

Ø12-14 mm HALAT ŞİŞESİ | ROPE ATTACHMENT

EN13411-7

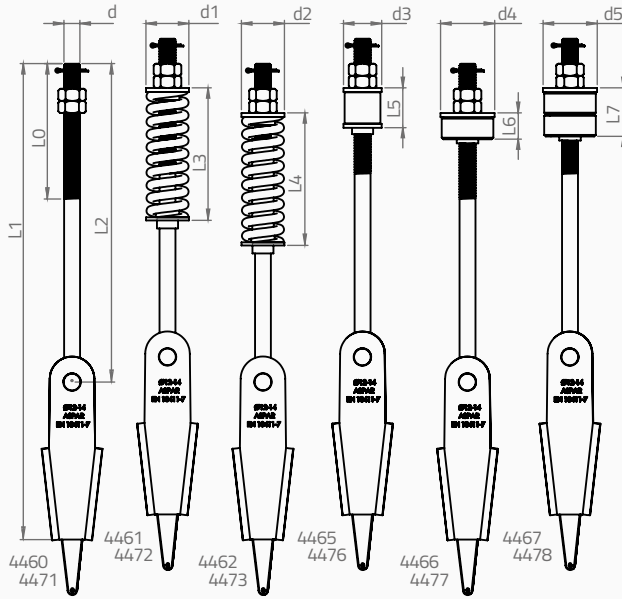
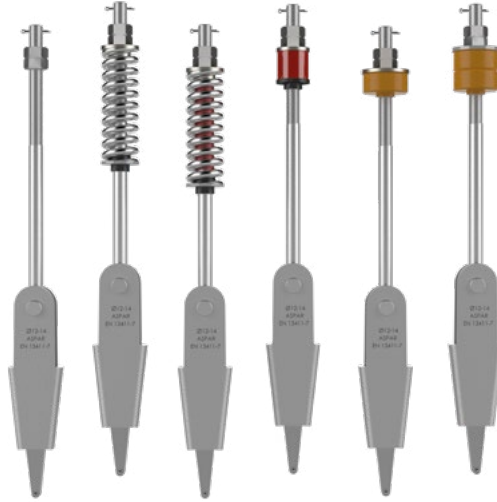

TÜM METAL YÜZEYLER GALVANİZ KAPLANMIŞTIR
ALL SURFACE ARE GALVANIZED

TÜM HALAT ŞİŞELERİ HALAT KOPMA YÜKÜ (105 kN)
TESTLERİNDEN BAŞARI İLE GEÇMİŞTİR
ALL THE ROPE ATTACHMENTS PASSED THE ROPE BREAKING FORCE
(105 kN) TESTS SUCCESSFULLY.

KOD/CODE	L0	L1	L2	L3	L4	L5	L6	L7	d	d1	d2	d3	d4	d5
4460	170	598	400						M20					
4461	170	598	400	167					M20	54				
4462	170	598	400		167				M20		54			
4465	170	598	400			50			M20			48		
4466	170	598	400				33		M20				68	
4467	170	598	400					61	M20					68
4471	450	878	680						M20					
4472	450	878	680	167					M20	54				
4473	450	878	680		167				M20		54			
4476	450	878	680			50			M20			48		
4477	450	878	680				33		M20				68	
4478	450	878	680					61	M20					68

EN13411-7

Ø12-14 mm
GÖVDE | BODY

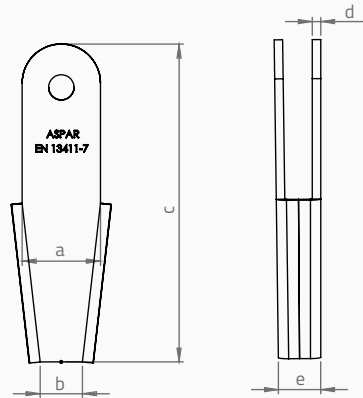

MALZEME | MATERIAL
SAC GÖVDE | SHEETIRON

a	b	c	d	e
58	32	230	8	36

EN13411-7

Ø12-14 mm
KAMA | WEDGE

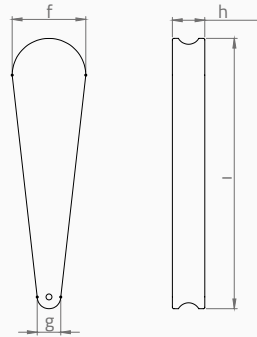

MALZEME | MATERIAL
PIK DÖKÜM | CASTIRON
EN-GJMW-400-5
EN-GJL-200

f	g	h	i
38	12	18	141

EN13411-7

Ø12-14 mm
PİM | PIN

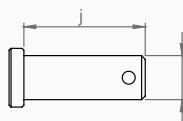

MALZEME | MATERIAL
METAL | ROUND METAL BAR
10083 - 1 C 35 E

j	k
55	Ø18

Ø12-14 mm
POLIÜRETAN LASTİK | POLYURETHANE CABLE BUFFER

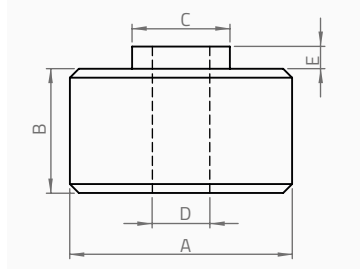
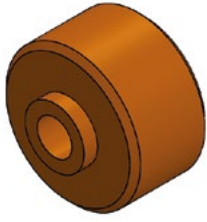

TİP TYPE	A	B	C	D	E
L6 - L7	65	28	27	21	5

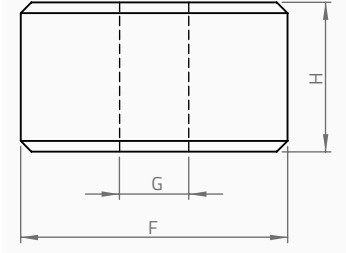
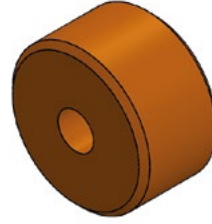

TİP TYPE	F	G	H
L6	65	21	28

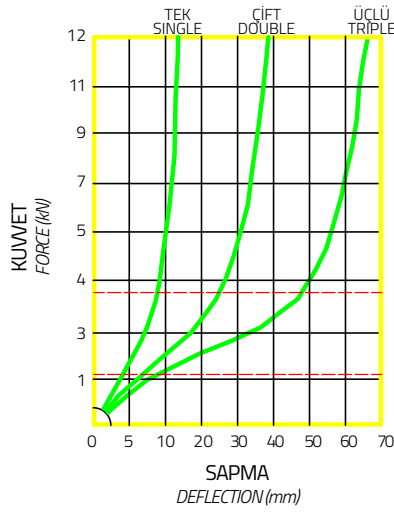

Ø12-14 mm
PVC LASTİK | PVC CABLE BUFFER

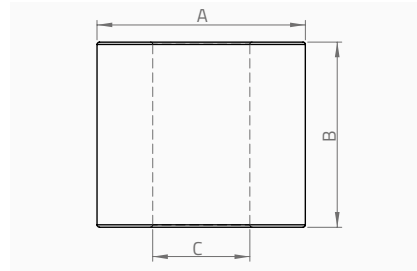
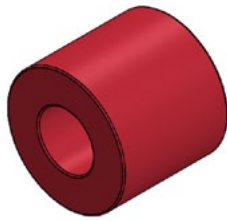

TİP TYPE	A	B	C
L5	45	40	21

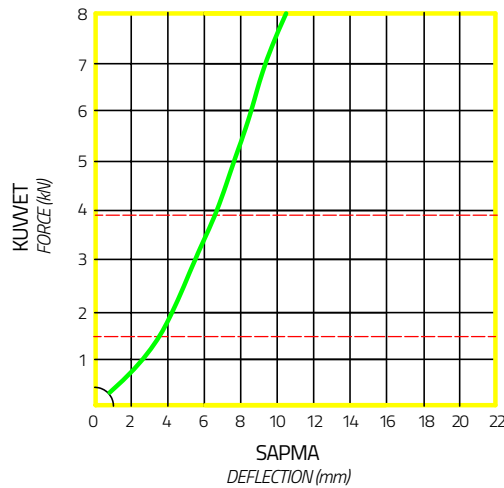

Ø12-14 mm YAY | SPRING

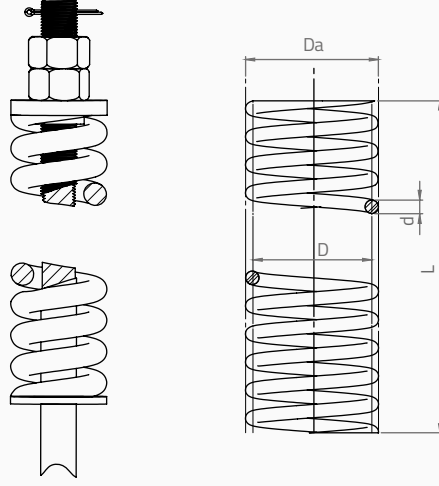

MALZEME | MATERIAL
DIN 17223 B - EN 10270B

DİŞ ÇAP OUTER DIAMETER	MERKEZ ÇAPI MID THREAD DIAMETER	TEL ÇAPI DIAMETER SPRING WIRE	BOY UNSTRESSED LENGHT	KUVVET ELESTIC FORCE	STROK RANGE OF SPRING	YAY SABİTİ SPRING RATE CONSTANT
mm	mm	mm	mm	N	mm	N/mm
Da	D	d	L	F	L1	k
53	42	11	157,5	7758	30	256,17

Ø12-14 mm YAY BORUSU | SPRING STOPPER

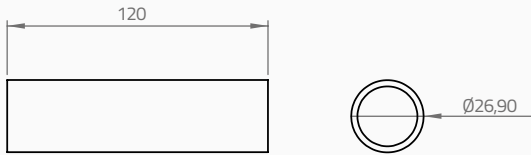

MALZEME | MATERIAL
METAL | METAL

KOLİ BİLGİLERİ | PACKING MEASURE

ÜRÜN ADI PRODUCT DESCRIPTION	KOLİDEKİ ADET QUANTITY IN PACKAGE (pcs)	EN WIDTH (cm)	BOY LENGTH (cm)	YÜKSEKLİK HEIGHT (cm)	AĞIRLIK WEIGHT (kg)
Ø12-14 HALAT ŞİŞESİ Ø12-14 ROPE ATTACHMENT	8	21	50	14	19

Ø12-14 mm
4461 | 4462 | 4472 | 4473

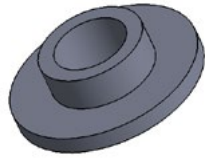

METAL
SHEET IRON



KAUÇUK
RUBBER

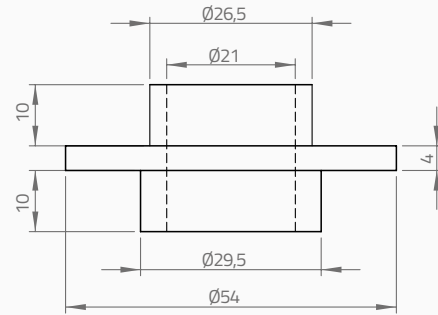
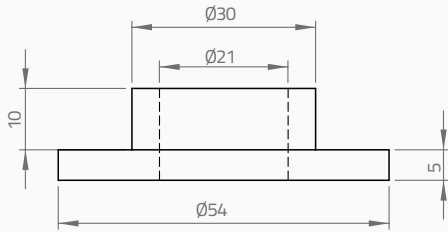

Ø12-14 mm
4465 | 4476



METAL
SHEET IRON



POLYAMİD
POLYAMIDE

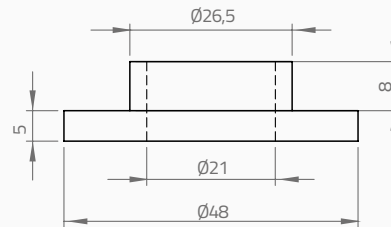
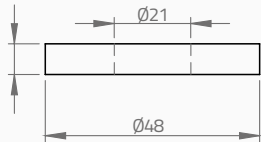

Ø12-14 mm
4466 | 4467 | 4477 | 4478



METAL
SHEET IRON

